



SOT8023

WLCSP8; Reel dry pack for SMD, 7"; Q1/T1 product orientation

Rev. 1 — 21 November 2022

Packing information

1. Packing method

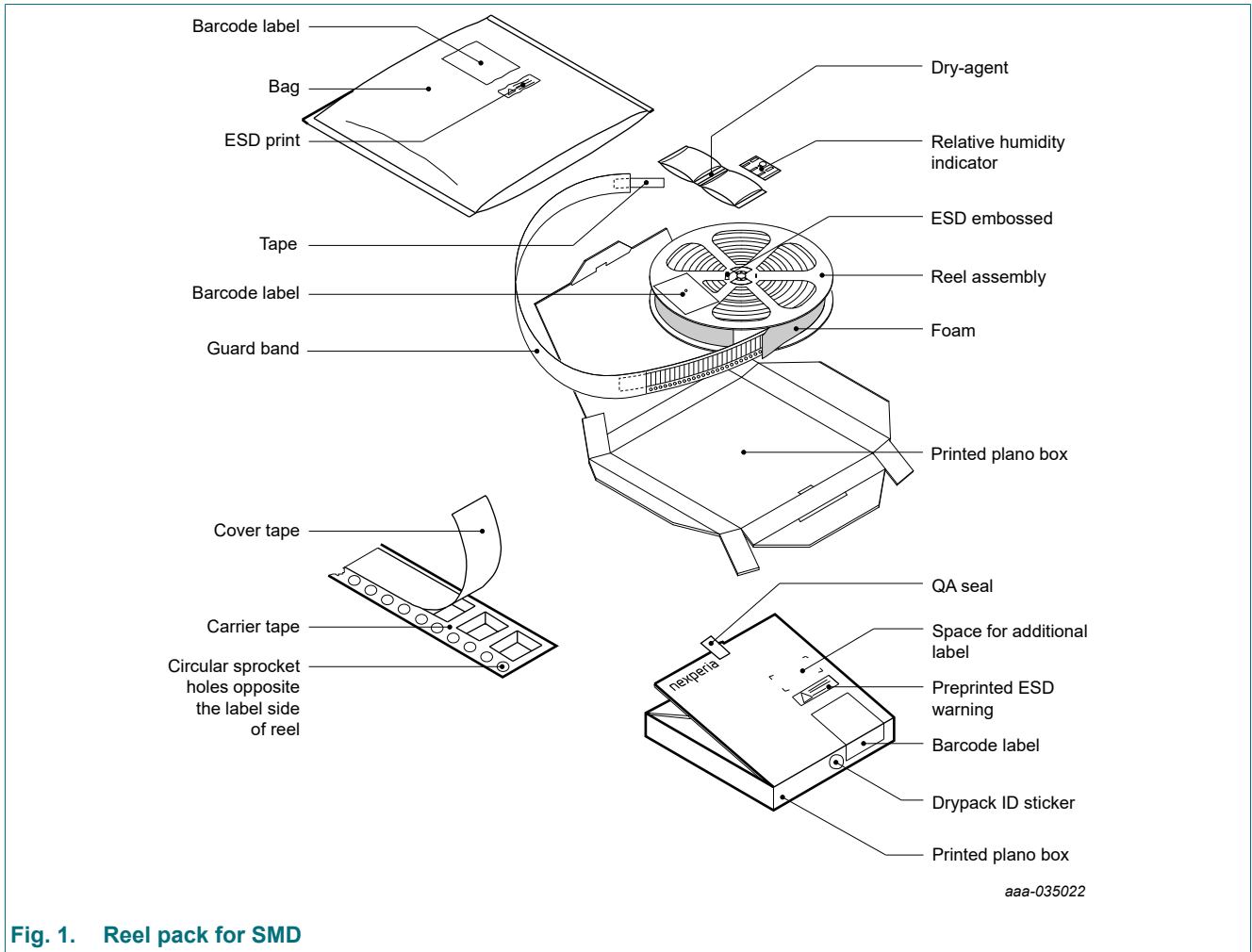

Fig. 1. Reel pack for SMD

Table 1. Dimensions and quantities

Package version	12 NC ending	Orderable part number ending	Reel dimensions d × w (mm)[1]	SPQ/PQ (pcs)[2]	Reels per box	Outer box dimensions l × w × h (mm)[3]
SOT8023	336	336 or Z	180 x 8	8000	1	208 x 206 x 31

[1] d = reel diameter; w = tape width.

[2] Packing quantity dependent on specific product type. Please contact your local Nexperia representative for ordering.

[3] Dimensions for reference only.

2. Product orientation

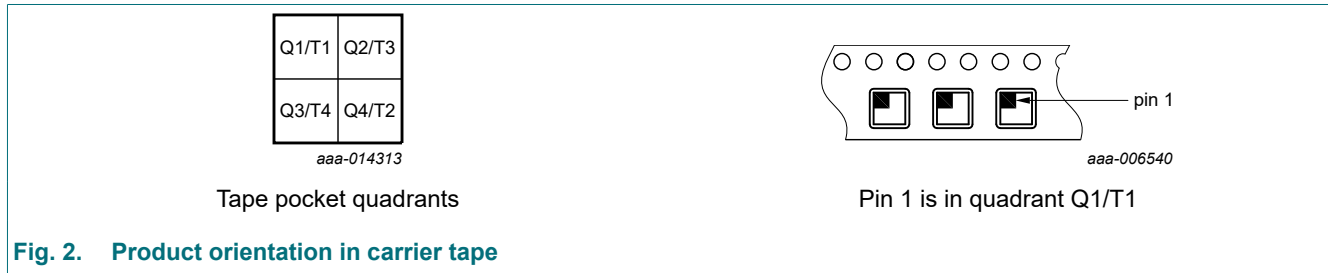

3. Carrier tape dimensions

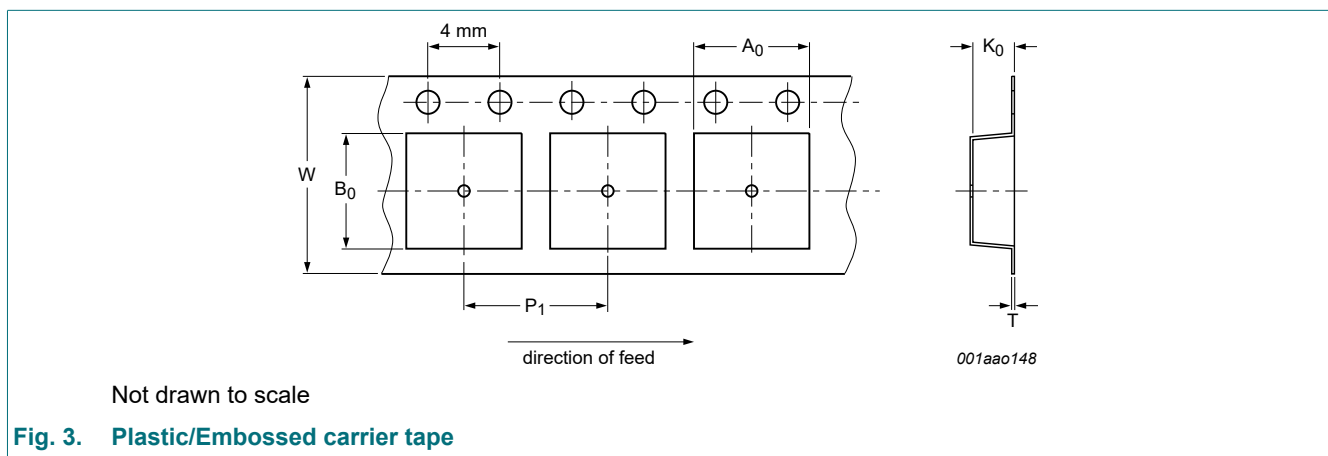

Table 2. Carrier tape dimensions

In accordance with IEC 60286-3

A ₀ (mm)	B ₀ (mm)	K ₀ (mm)	T (mm)	P ₁ (mm)	W (mm)
0.84 ± 0.03	1.66 ± 0.03	0.69 ± 0.03	0.23 ± 0.02	2.0 ± 0.05	8.0 +0.3 / -0.1

4. Reel dimensions



Fig. 4. Schematic view of reel

Table 3. Reel dimensions

In accordance with IEC 60286-3

A [nom] (mm)	W2 [max] (mm)	B [min] (mm)	C [min] (mm)	D [min] (mm)
180	14.4	1.5	12.8	20.2

5. Barcode label



Fig. 5. Example of typical box information barcode label

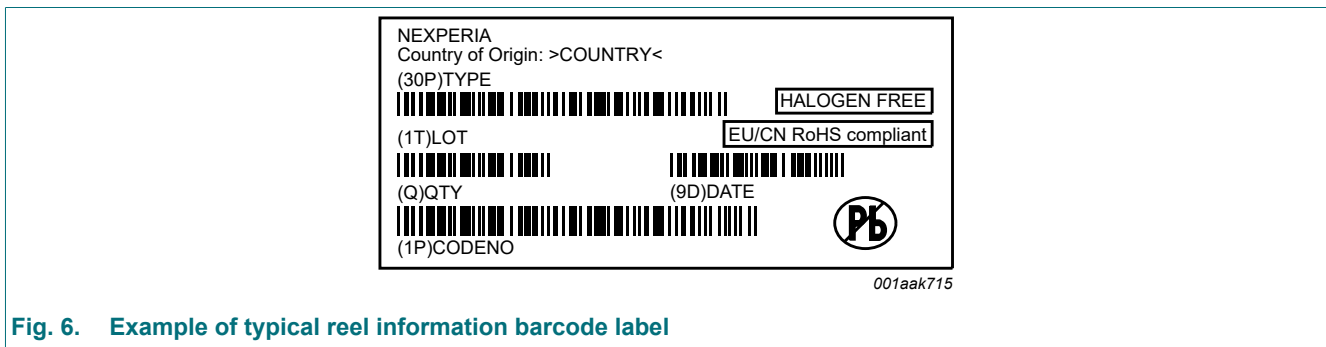

Fig. 6. Example of typical reel information barcode label

Table 4. Barcode label dimensions

Box barcode label l × w (mm)	Reel barcode label l × w (mm)
100 × 75	36 × 75

6. Revision history

Table 5. Revision history

Document ID	Release date	Modifications	Supersedes
SOT8023_336 v. 1	20221121	-	-

7. Legal information

Definitions

Draft — The document is a draft version only. The content is still under internal review and subject to formal approval, which may result in modifications or additions. Nexperia does not give any representations or warranties as to the accuracy or completeness of information included herein and shall have no liability for the consequences of use of such information.

Disclaimers

Limited warranty and liability — Information in this document is believed to be accurate and reliable. However, Nexperia does not give any representations or warranties, expressed or implied, as to the accuracy or completeness of such information and shall have no liability for the consequences of use of such information. Nexperia takes no responsibility for the content in this document if provided by an information source outside of Nexperia.

In no event shall Nexperia be liable for any indirect, incidental, punitive, special or consequential damages (including - without limitation - lost profits, lost savings, business interruption, costs related to the removal or replacement of any products or rework charges) whether or not such damages are based on tort (including negligence), warranty, breach of contract or any other legal theory.

Notwithstanding any damages that customer might incur for any reason whatsoever, Nexperia's aggregate and cumulative liability towards customer for the products described herein shall be limited in accordance with the Terms and conditions of commercial sale of Nexperia.

Right to make changes — Nexperia reserves the right to make changes to information published in this document, including without limitation specifications and product descriptions, at any time and without notice. This document supersedes and replaces all information supplied prior to the publication hereof.

Suitability for use — Nexperia products are not designed, authorized or warranted to be suitable for use in life support, life-critical or safety-critical systems or equipment, nor in applications where failure or malfunction of an Nexperia product can reasonably be expected to result in personal injury, death or severe property or environmental damage. Nexperia and its suppliers accept no liability for inclusion and/or use of Nexperia products in such equipment or applications and therefore such inclusion and/or use is at the customer's own risk.

Applications — Applications that are described herein for any of these products are for illustrative purposes only. Nexperia makes no representation or warranty that such applications will be suitable for the specified use without further testing or modification.

Customers are responsible for the design and operation of their applications and products using Nexperia products, and Nexperia accepts no liability for any assistance with applications or customer product design. It is customer's sole responsibility to determine whether the Nexperia product is suitable and fit for the customer's applications and products planned, as well as for the planned application and use of customer's third party customer(s). Customers should provide appropriate design and operating safeguards to minimize the risks associated with their applications and products.

Nexperia does not accept any liability related to any default, damage, costs or problem which is based on any weakness or default in the customer's applications or products, or the application or use by customer's third party customer(s). Customer is responsible for doing all necessary testing for the customer's applications and products using Nexperia products in order to avoid a default of the applications and the products or of the application or use by customer's third party customer(s). Nexperia does not accept any liability in this respect.

Export control — This document as well as the item(s) described herein may be subject to export control regulations. Export might require a prior authorization from competent authorities.

Translations — A non-English (translated) version of a document is for reference only. The English version shall prevail in case of any discrepancy between the translated and English versions.

Trademarks

Notice: All referenced brands, product names, service names and trademarks are the property of their respective owners.